

## Palatine Models

### 6ft 4ins, 8ft 6ins & 9 foot twin torsion bar bogie kit

The twin torsion bar bogie kit has been designed to give a smooth and resilient ride for coaches weighing from 200—300 grams.

Etched in .015" nickel silver the bogie utilises a top bolster attached to side frames with 0.8mm (1/32") rivets. Intended as a strong base for cosmetic sides in plastic or whitmetal it incorporates footboard brackets and tiebars either flat or twisted through 90 degrees.

A simple jig will aid assembly and this is simply made from a 3 inch square piece of 6mm plywood.

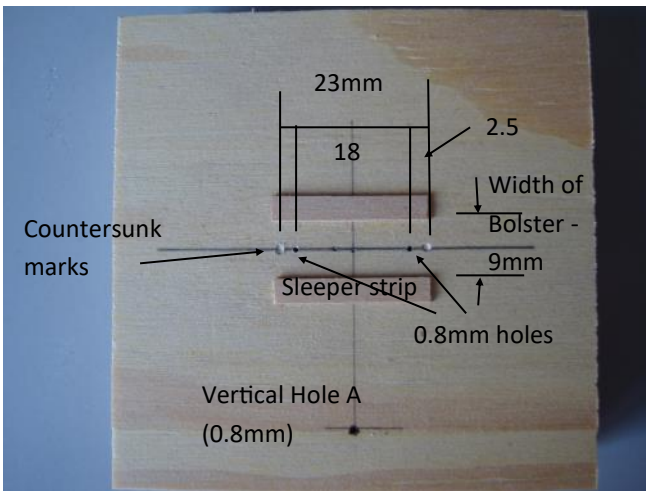

The wooden strips are P4 sleeper strip glued down to locate the bolster during assembly. Vertical holes are drilled at 18mm centres to keep the rivets vertical during soldering. Dimples the width of the rivet head are made at 23mm centres to support rivets during assembly. You can use any stripwood for the jig.

The design assumes wheels with the standard 26mm over pin-point axles. 0.15mm packing washers are supplied to be placed behind the bearing flanges when axle lengths are shorter than 26mm.

#### Bolster

1. Remove the bolsters from the fret and fold the 'ears' back on themselves making a 180 bend. Solder them ensuring they are flat. Fold the sides to 90 degrees.
2. Clear the etched holes with a 0.85mm drill and lightly countersink the top and bottom.

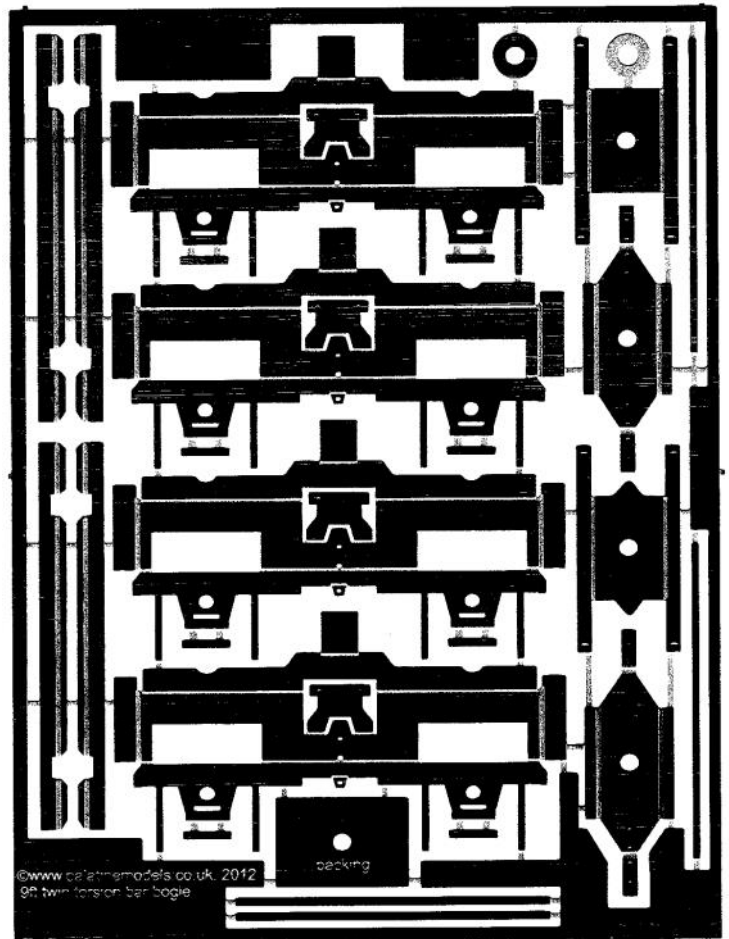

#### Sides

1. Press out the dimples in the axle box keeps to form bolt heads. Clear torsion bar holes with a 0.65mm drill and drill out the rivet holes with a 0.85mm drill.
2. Fold up the sides using attached diagram for the fold order and solder the stay to the torsion bar drop bracket.
3. Solder rivet to the underside of frame in the inner hole using jig (hole A) to ensure rivet is vertical.

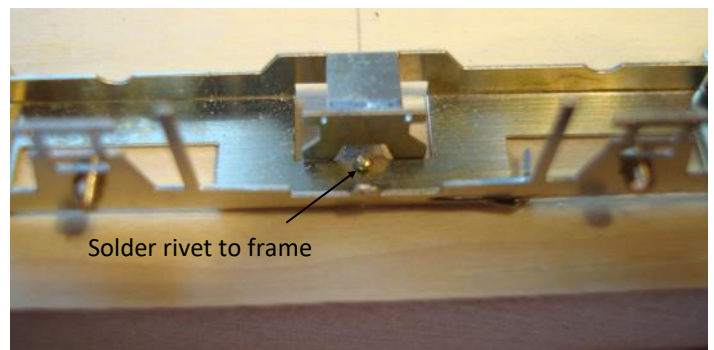

4. Fold over the small tag with a hole in it on the frame and ensure that a rivet will fit vertically through the holes. Use a broach to clear out the holes.
5. Open out the bearing holes and solder bearings in place. We have found that the length of wheel axles vary wildly and we always measure them first and keep similar length axles in

one bogie. 25.75mm is common and the 2mm washers are provided as packing behind the bearings. Similarly we have found that some wheel bearings don't match the pinpoint on the axle so we always check each one with the wheel before use.

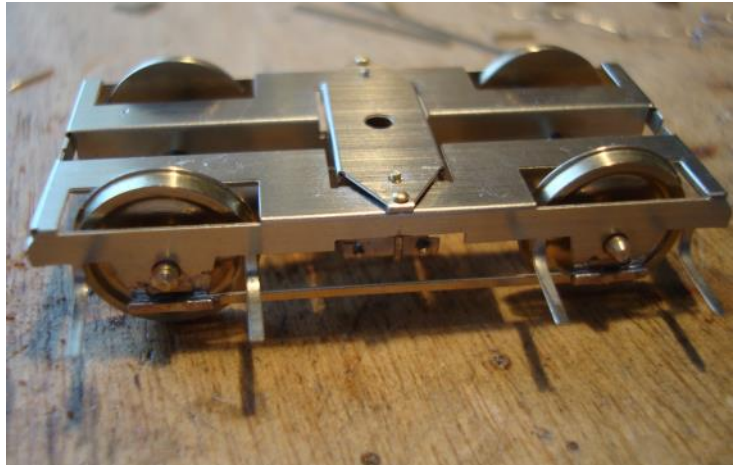

**Assembly (utilising jig)**

1. Insert 2 rivets in the end holes through the top of the bolster—DO NOT SOLDER, invert and place on the jig ensuring the heads locate in the countersinks and place 0.4mm spacer to maintain gap between bolster and side frame. (The etch frame or tie bars can be used if required).
2. Invert the side and place over the rivet simultaneously inserting the inside rivet in the inner hole in the jig.
3. Solder toe of outer rivet in the bent over tag on the frame.
4. Repeat for the other side.
5. Cut 0.6mm brass wire 23mm long and bend 2mm at 90 degrees. Thread the wire through the bracket holes and solder one end only at diagonally opposite ends.
6. Decide if you are going to use the footboard brackets. If you are you can trim them shorter at this stage—we usually cut them to align with the bottom of the bearing carrier. If you are not going to use them cut them off at the top of the frame.
7. Remove from jig and insert wheels and place on a flat surface, still inverted. Hold sides together and solder remaining ends of torsion bars ensuring that axles have no end float but still revolve freely.
8. Trim torsion bar ends to within 0.5mm of outside of brackets to leave space for cosmetic bolster spring detail.
9. Trim rivets but leave a little proud. DO NOT SOLDER rivet to bolster.

2. Assemble the tube to the coach underframe with an M2 screw and solder the nut and tube in place. Remove screw.
3. Place crossmembers over the tube trimming the ends to suit the solebars. Bend up the supports on one end and strengthen with solder after checking height which should be 2mm
4. Cut and place 3mm diameter tube 2mm long over the 2.5mm tube at the other end and check ride height. When satisfied solder the 3mm tube in place.
5. Bend up the stepboard brackets using a large radius if you are using them.
6. Solder tie bars to the bottom of the frame and fold over the keeps and solder them in place. File off the fold over tabs. If the tiebars are edge-on and not side-on fold through 90 degrees after they have been soldered to the keeps.
7. If required, after mounting your cosmetic bogie side-frames fold up stepboards and apply to the stepboard brackets. These are designed so that they can be used as either a long or short version. For short versions cut using the mark on the underside of the stepboard.

**Coach underframe**

1. Prepare 2 lengths of the 2.5mm diameter tube 5mm long—file the ends square.

*Note: Exactoscale wheels 14.5mm diameter  
 Studiolith/Gibson wheels 14.4/14.3mm diameter  
 Ultrascale wheels 14.1/14.0mm diameter*

Sketch drawing showing height dimensions of bogie, bolster and support.

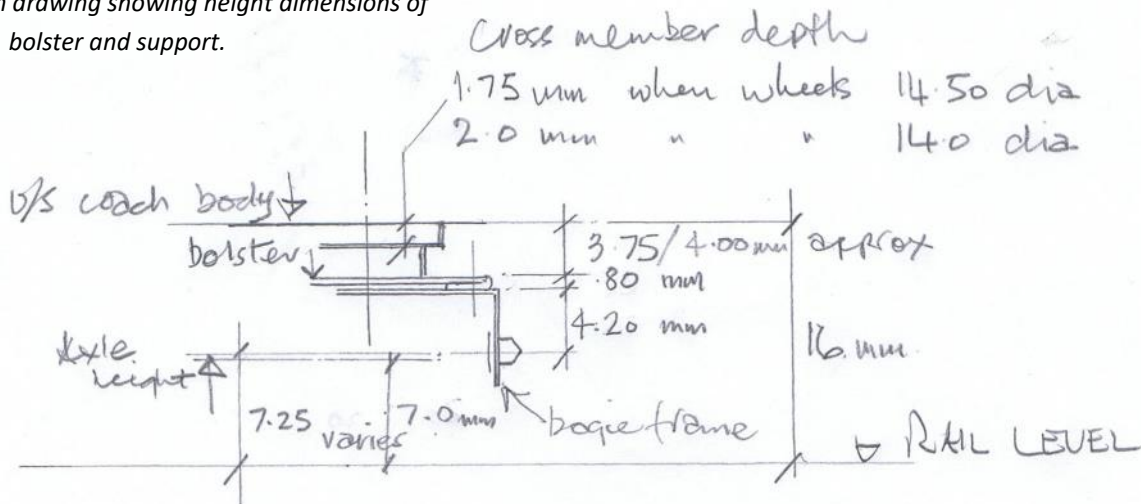

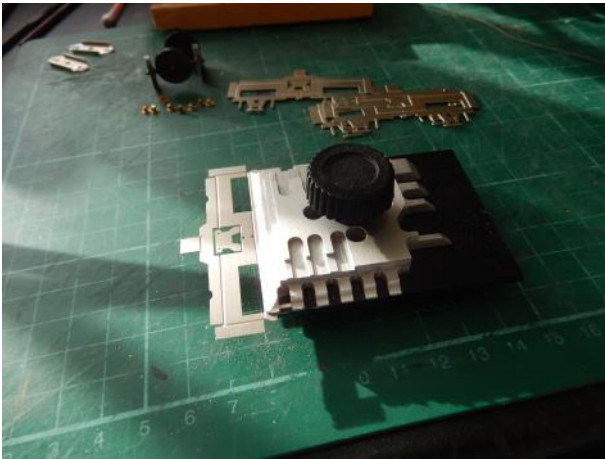

First fold—Clamp the wheel bearing side and fold up so you create a right angle. We use the Hold and Fold 'Bug' which is exactly the right size but a vice or folding bars or lengths of wood would also do the job.

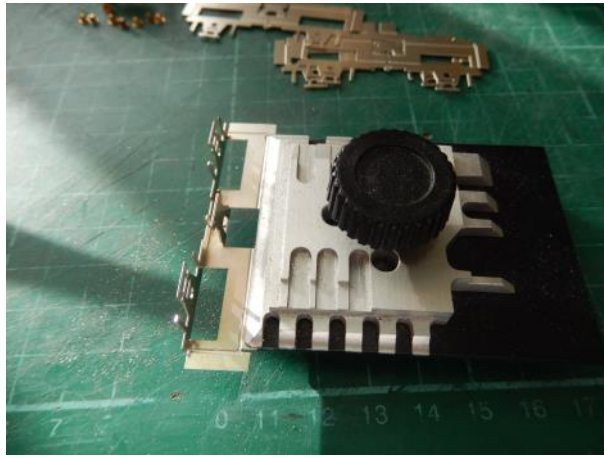

Second fold—Bend the torsion bar bracket up far enough so it will clear once the next fold is made. Bend the inner frame at right angles and check to ensure everything is square before progressing.

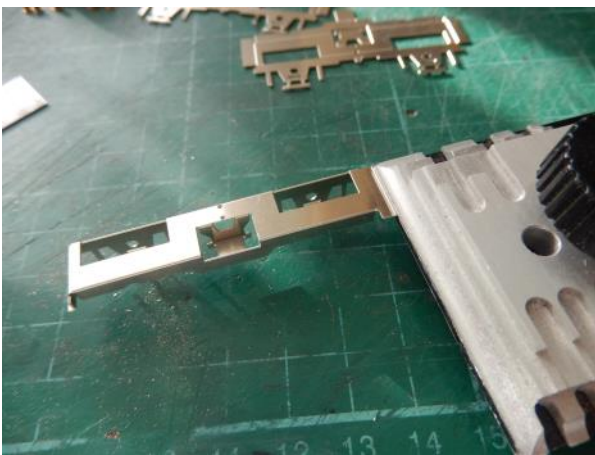

Third fold—Before making the third fold ensure that the etching cusp is filed off the part shown here being held in the clamp. Hold the outer part of the end frame and bend upwards to form a right angle.

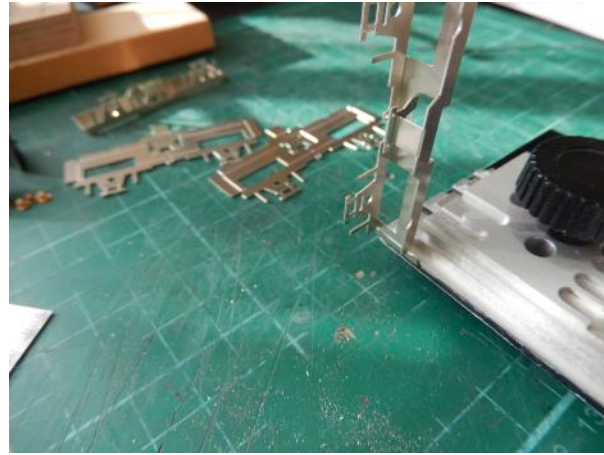
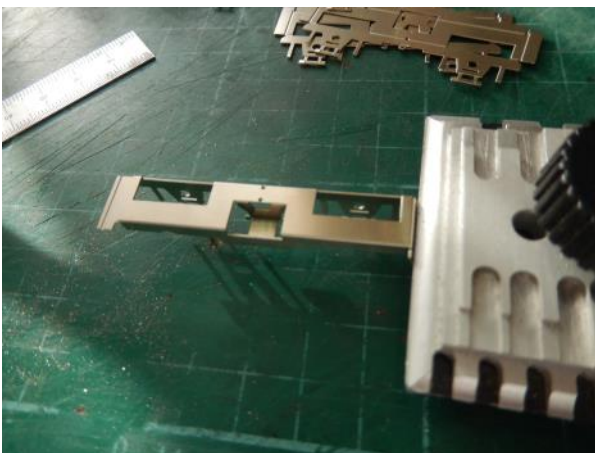
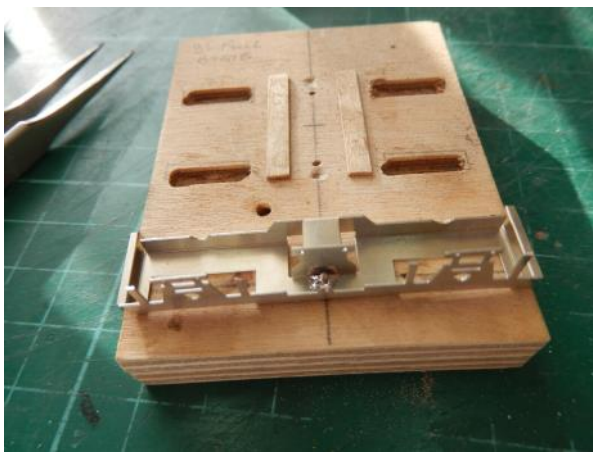

Photo shows fold being made in the end frame. For 6ft 4ins bogie simply fold down the remaining part of the end frame as shown below.



Fourth fold—Whilst the Bug is still holding the end fold bend down the whole bogie sideframe to form a right angle. Check the formation and tweak where necessary.



Completed bogie sideframe positioned in jig showing the rivet soldered in place. The wheel recesses in the jig are not necessary (this was an early jig which has now been simplified).

**PHOTO PAGE 2**

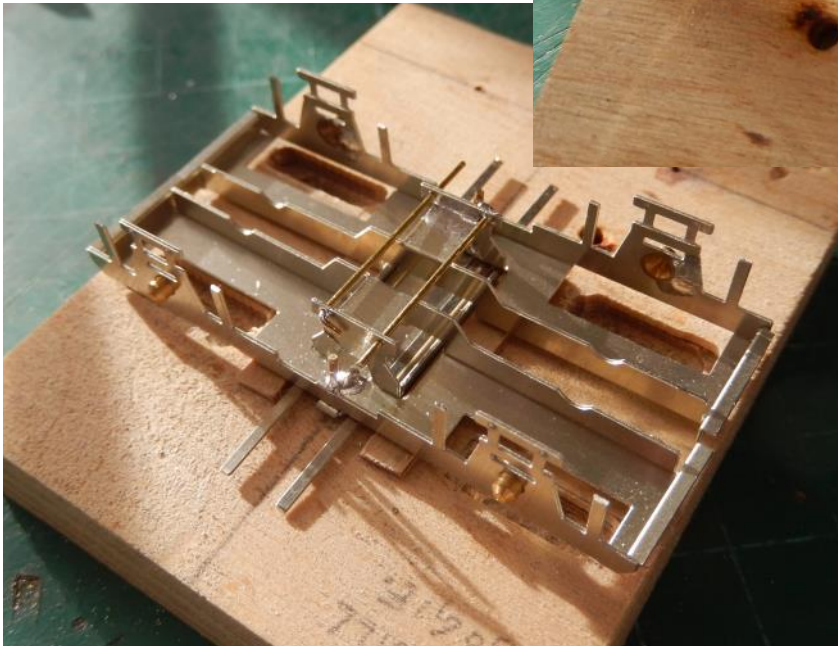
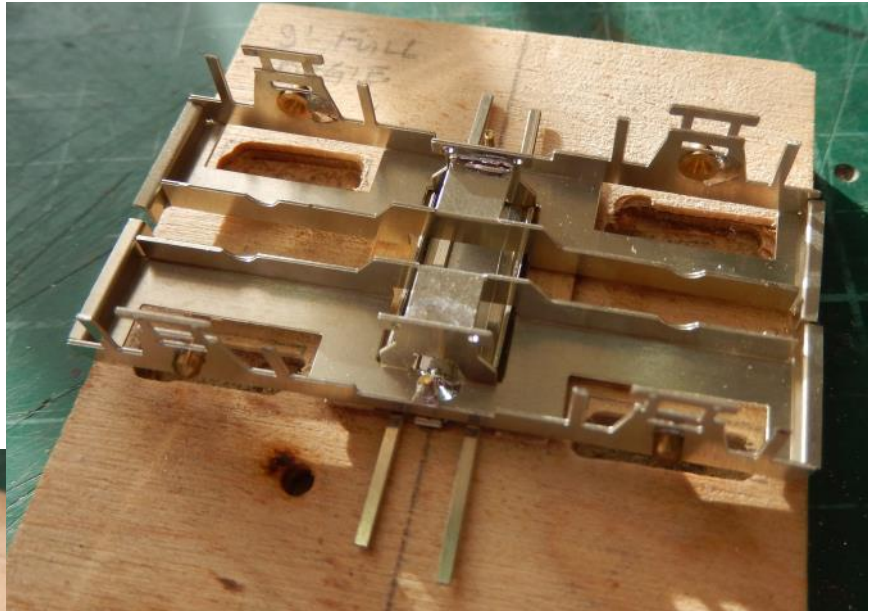

Bearings soldered in and torsion bars soldered at opposite ends only. Packing pieces are tie bar strips from the etch. Step-board brackets have been shortened.

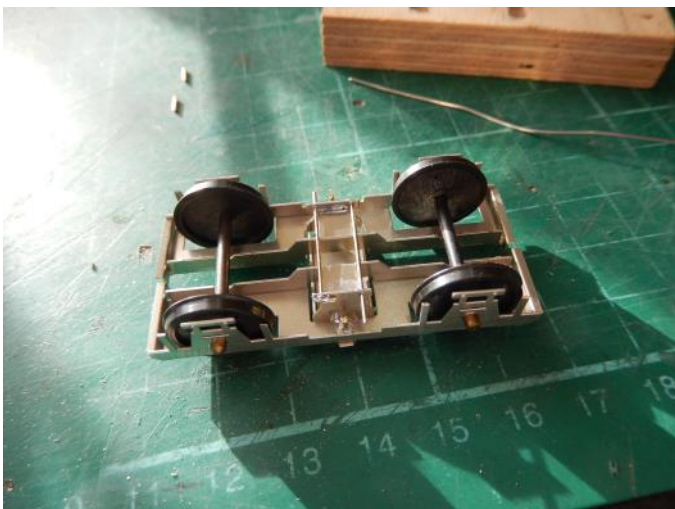

Wheels put in place after the inner rivets have been shortened so that the bogie can be turned over. Torsion bars are soldered to the brackets gently squeezing both sideframes together so there is little or no sideplay in the wheel bearings.

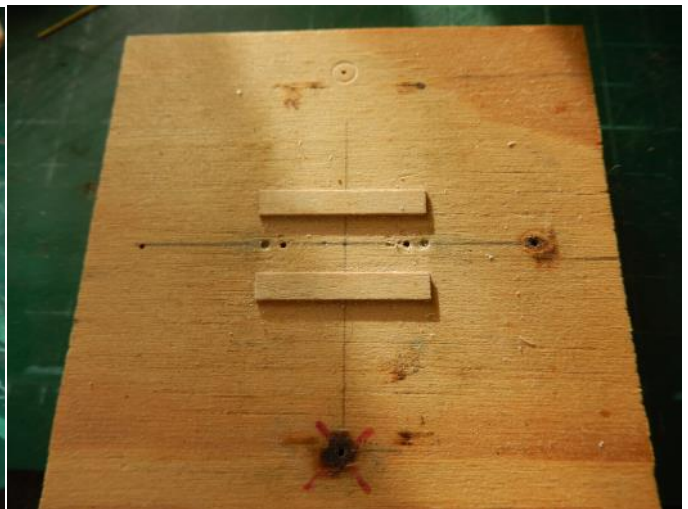

Assembly jig showing holes which have been drilled to ensure they are truly vertical.